

RGBW Multi-Colour Touch Panels

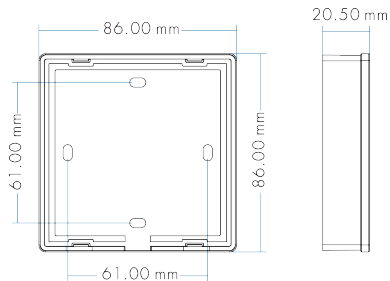
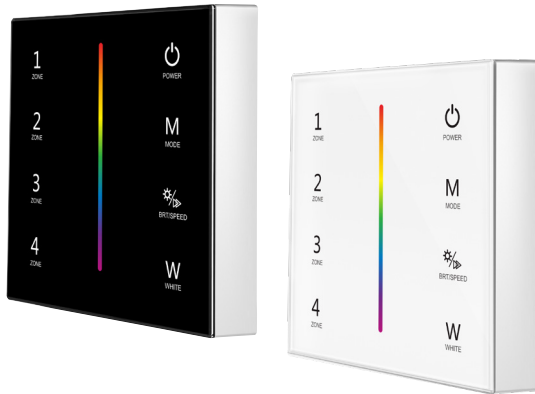

T24 Wireless Touch Panel RGBW 4 Zone

- High strength glass touch panel with touch colour slide in middle
- Application: Surface mount, wireless panel
- 4 Zone panel, for independent control. Can be paired to multiple receivers
- Finish/Colour: White, Black
- Dimensions: 86mmW x 86mmH x 20.5mmD
- IP20, non-waterproof
- Power AAA battery (2pc) (included)
- Used in conjunction with VP controller

T24-BK (black) **T24-WH** (white)

Wall Mounted Touch Panel

Model No.: T21, T22, T24, T25

4 Zone/1-5 color/Glass touch panel/Color slide/Wireless remote 30m distance/AAA x 2 battery



T21
4 Zone dimming



T22
4 Zone CCT



T24
4 Zone RGB/RGBW



T25
4 Zone RGB+CCT

Features

- Touch panel 4 zone 1-5 color RF remote.
- Each zone can remote control multiple RF 2.4G LED controllers.
- Ultra sensitive high strength glass touch panel with touch color slide in the middle.
- Smooth and accurate color adjustment by touching the color slide.
- Touch keys with chord tones and LED indicator.
- Free installation, no wiring, removable.
- AAA x 2 battery powered.
- White & Black glass panel available.

CE RoHS EMC LVD RED

Technical Parameters

Input and Output	
Output signal	RF(2.4GHz)
Working voltage	3VDC(AAA x 2)
Working current	< 5mA(Without tune)
	< 20mA(with tune)
Standby current	< 20µA
Standby time	1 year
Remote distance	30m (Barrier-free space)

Environment	
Operation temperature	Ta: -30°C ~ +55°C
Case temperature (Max.)	Tc: +65°C
IP rating	IP20

Safety and EMC	
EMC standard (EMC)	ETSI EN 301 489-1 V2.2.3 ETSI EN 301 489-17 V3.2.4
Safety standard(LVD)	EN 62368-1:2020+A11:2020
Radio Equipment(RED)	ETSI EN 300 328 V2.2.2
Certification	CE,EMC,LVD,RED

Warranty	
Warranty	5 years

Weight	
Net weight	156g
Gross weight	192g

Mechanical Structures and Installations

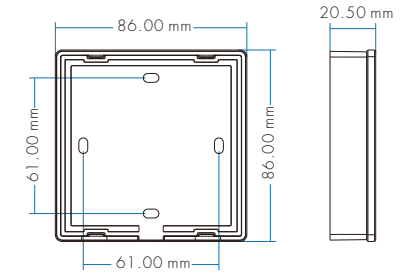
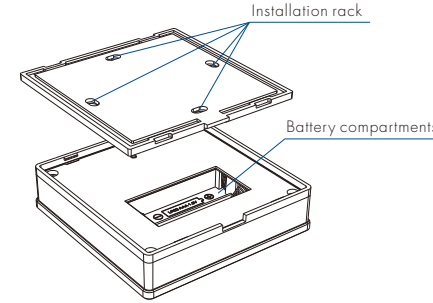

Installation diagram:

Typical base as below:

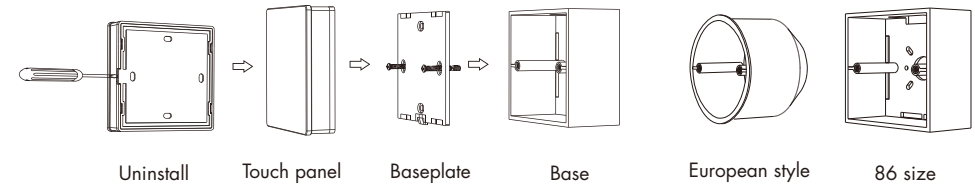

To fix the panel, two options are offered for selection:

- Option 1: fix it on the wall with two screws.
- Option 2: adhere it to the wall with paster.

Match with RF LED controller (two match ways)

End user can choose the suitable match/delete ways. Two options are offered for selection:

Use the controller's Match key

Match:
Short press match key, immediately press zone key of the touch panel.

The LED indicator fast flash a few times means match is successful.

Delete:
Press and hold match key for 5s to delete all match. The LED indicator fast flash a few times means all matched remotes were deleted.

Use Power Restart

Match:
Switch off the power of the receiver, then switch on power, repeat again.
Immediately short press zone key 3 times on the touch panel. The light blinks 3 times means match is successful.

Delete:
Switch off the power of the receiver, then switch on power, repeat again.
Immediately short press zone key 5 times on the touch panel. The light blinks 5 times means all matched remotes were deleted.

Key function

T21 Single color panel

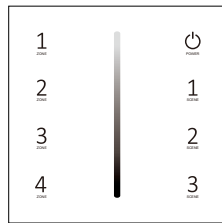

- Turn on/off all zone light.
- Brightness slide.
- Short press recall scene. Long press 2s to save the current state into 1/2/3.
- Short press turn on zone light and select zone simultaneously, long press 2s turn off zone light. Short press multiple zone key fastly, will select multiple zone synchronously. 4 zone control separately or synchronously, each zone could control multiple receivers.

T22 Dual color panel

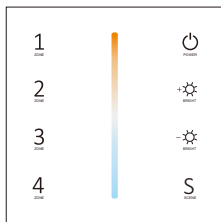

- Turn on/off all zone light.
- Color temperature.
- Brightness +, 10 levels.
- Brightness -, 10 levels.
- Short press recall scene. Long press 2s to save the current state into the scene.
- Short press turn on zone light and select zone simultaneously, long press 2s turn off zone light. Short press multiple zone key fastly, will select multiple zone synchronously. 4 zone control separately or synchronously, each zone could control multiple receivers.

T24 RGBW panel

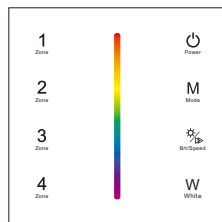

- Turn on/off all zone light.
- Color slide.
- Short press play 10 built-in mode, long press run mode-cycle.
- Adjust dynamic mode speed or static color brightness, 10 levels.
- Short press turn on/off W channel, long press adjust W channel brightness.
- Short press turn on zone light and select zone simultaneously, long press 2s turn off zone light. Short press multiple zone key fastly, will select multiple zone synchronously. 4 zone control separately or synchronously, each zone could control multiple receivers.

T25 RGB+CCT panel

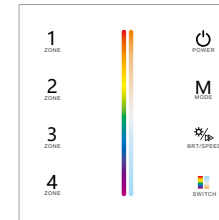

- Turn on/off all zone light.
- RGB color / Color temperature slide.
- Switch between RGB color / Color temperature slide.
- Short press play 10 built-in mode, long press run mode-cycle.
- Adjust dynamic mode speed or static color brightness, 10 levels.
- Short press turn on zone light and select zone simultaneously, long press 2s turn off zone light. Short press multiple zone key fastly, will select multiple zone synchronously. 4 zone control separately or synchronously, each zone could control multiple receivers.

Note: After touch power key to turn off light, long press power key for 5 seconds will turn on or turn off tone.

Safety information

1. Read all instructions carefully before you begin this installation.
2. When installing battery, pay attention to the battery positive and negative polarity. A long time without the remote control, remove the battery. When remote distance becomes smaller and insensitive, replace the battery.
3. If no response from the receiver, please re-match the remote.
4. Gently handle remote, beware of falling.
5. For indoor and dry location use only.